

TOP VIEW

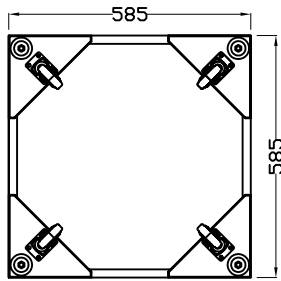

BOTTOM VIEW

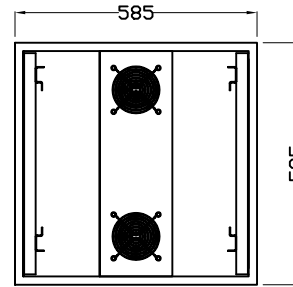

SECTION B-B

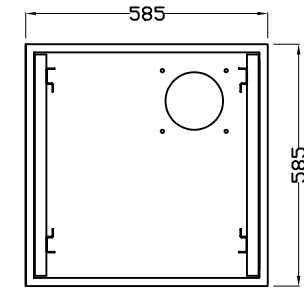

SECTION C-C

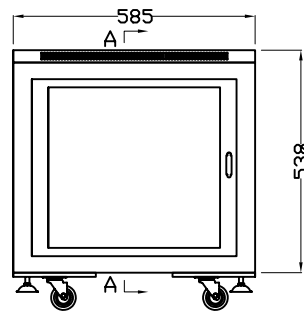

FRONT VIEW

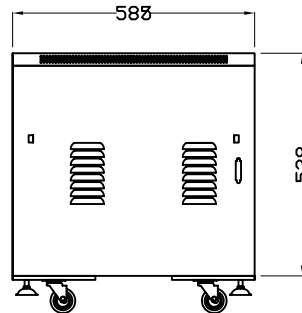

BACK VIEW

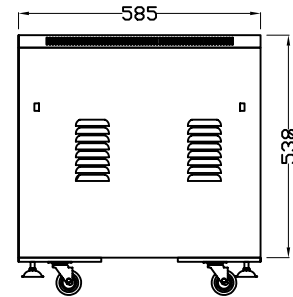

END VIEW

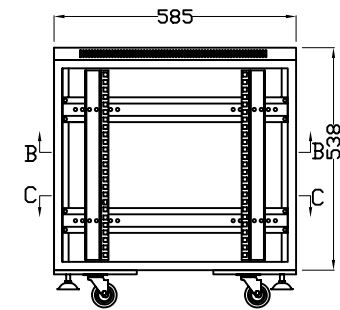

SECTION A-A



DRAWING:

RM8

SCALE 1:10

DRAWN
2007/07/30

DRAWING NO.

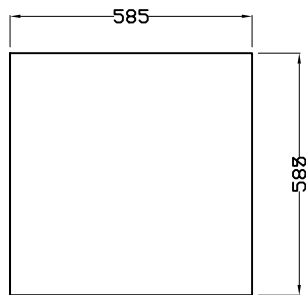

TOP VIEW

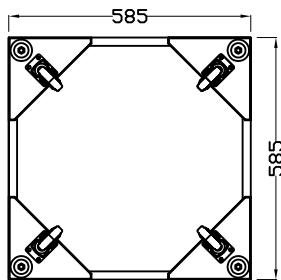

BOTTOM VIEW

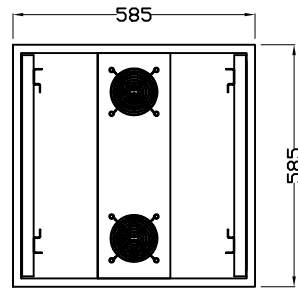

SECTION B-B

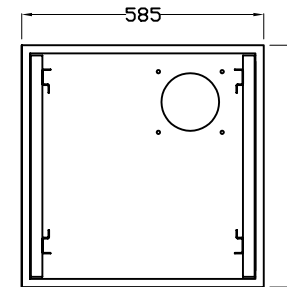

SECTION C-C

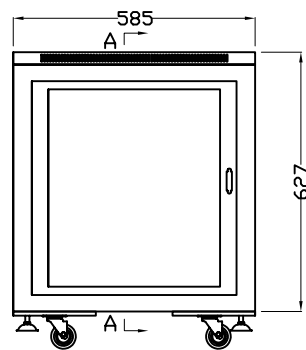

FRONT VIEW

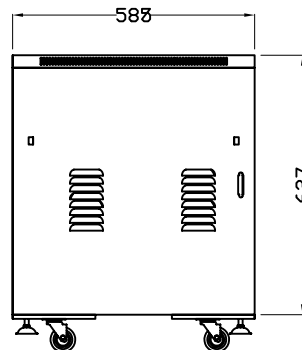

BACK VIEW

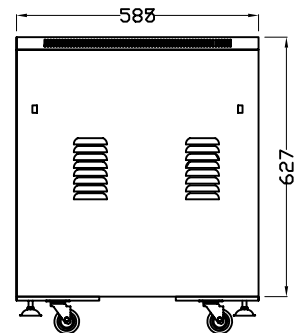

END VIEW

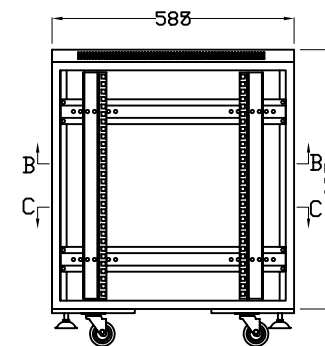

SECTION A-A



DRAWING:

RM10

SCALE 1:10

DRAWN
2007/07/30

DRAWING NO.

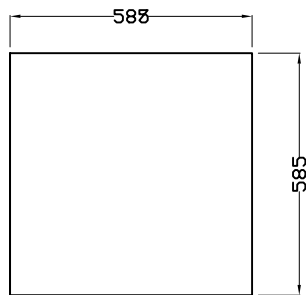

TOP VIEW

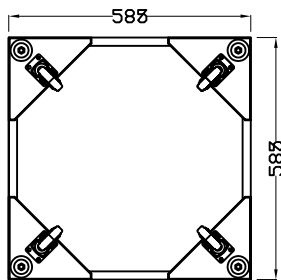

BOTTOM VIEW

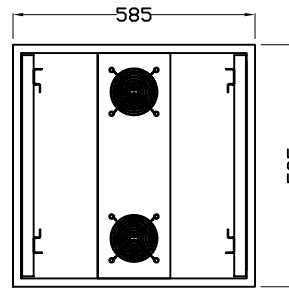

SECTION B-B

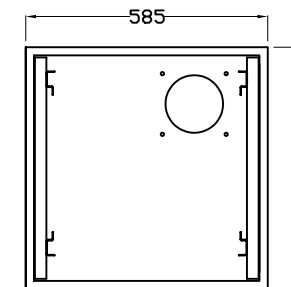

SECTION C-C

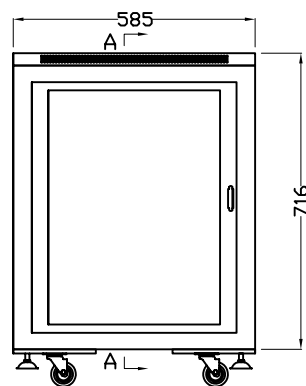

FRONT VIEW

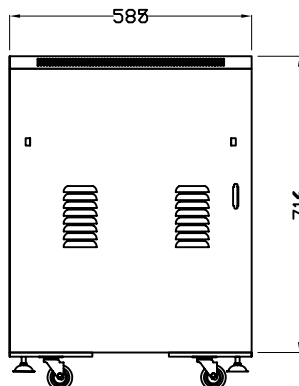

BACK VIEW

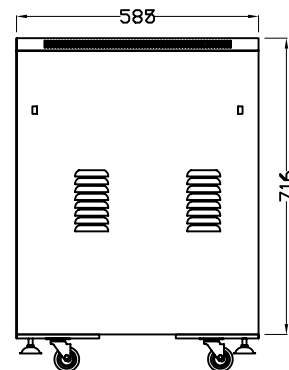

END VIEW

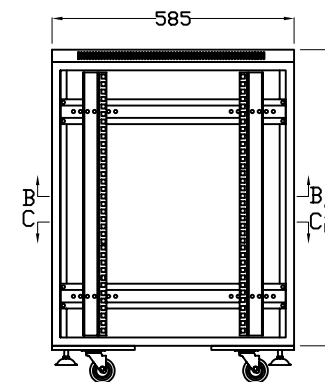

SECTION A-A



DRAWING:

RM12

SCALE 1:10

DRAWN
2007/07/30

DRAWING NO.

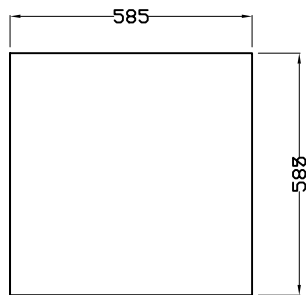

TOP VIEW

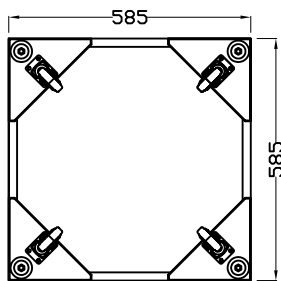

BOTTOM VIEW

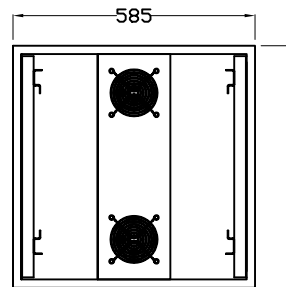

SECTION B-B

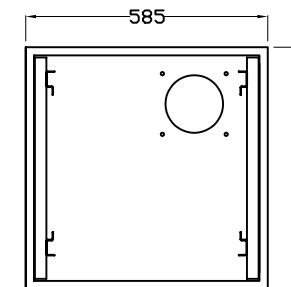

SECTION C-C

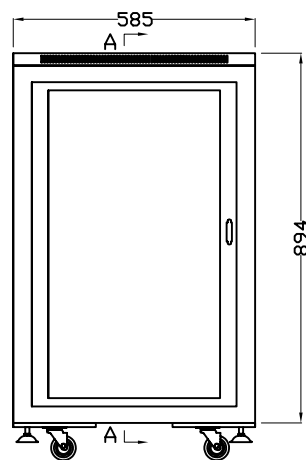

FRONT VIEW

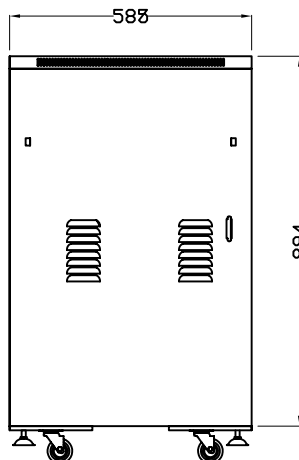

BACK VIEW

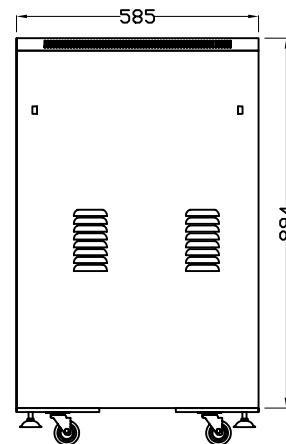

END VIEW

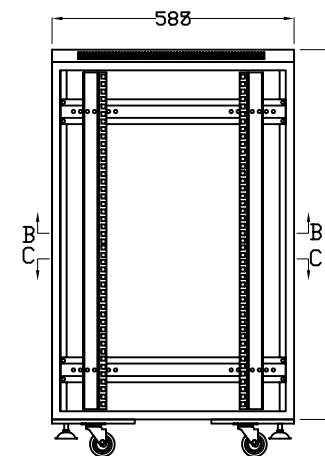

SECTION A-A



DRAWING:

RM16

SCALE 1:10

DRAWN
2007/07/30

DRAWING NO.

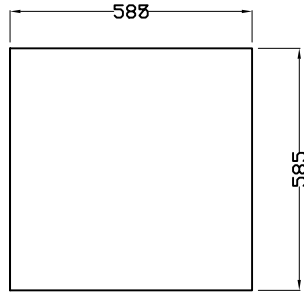

TOP VIEW

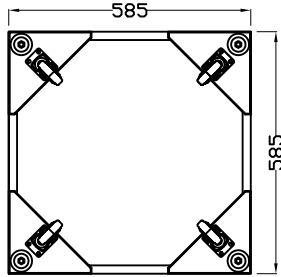

BOTTOM VIEW

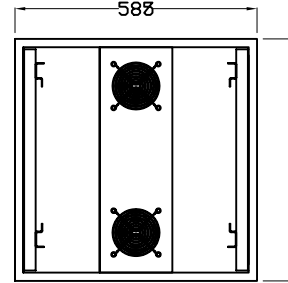

SECTION B-B

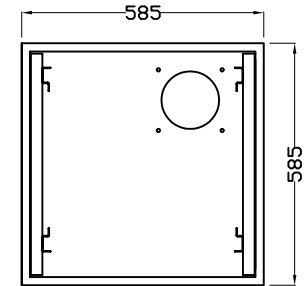

SECTION C-C

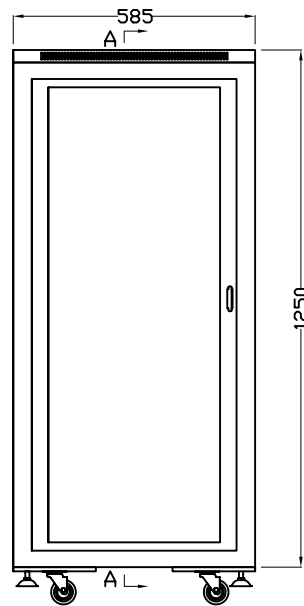

FRONT VIEW

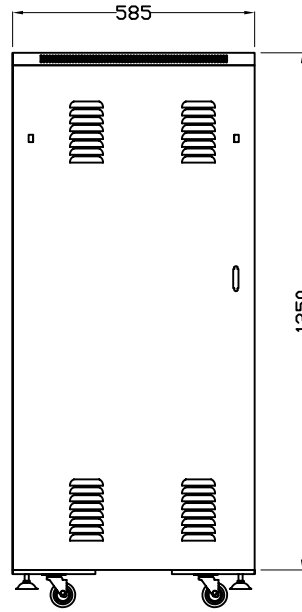

BACK VIEW

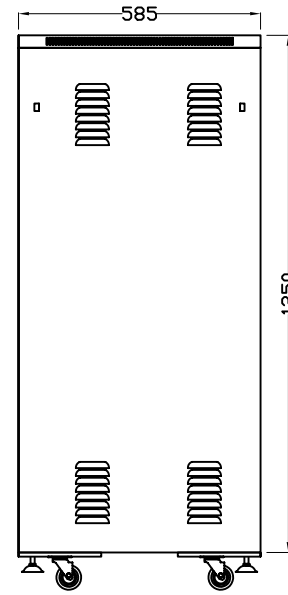

END VIEW

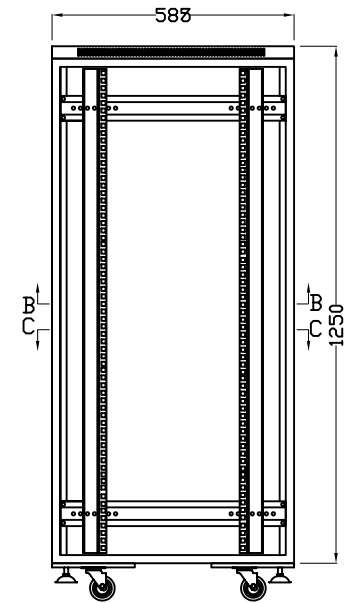

SECTION A-A



DRAWING:

RM24

SCALE 1:10

DRAWN
2007/07/30

DRAWING NO.

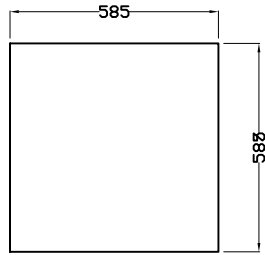

TOP VIEW

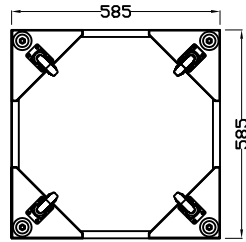

BOTTOM VIEW

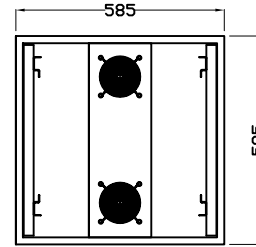

SECTION B-B

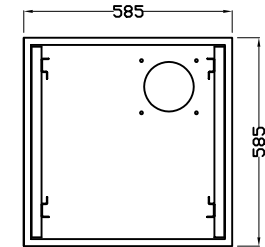

SECTION C-C

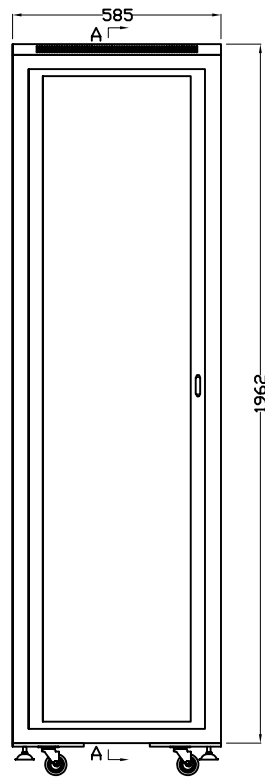

FRONT VIEW

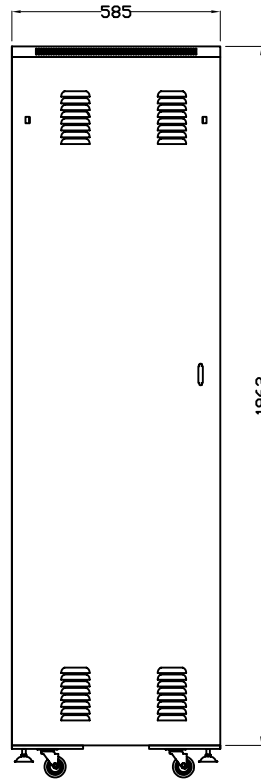

BACK VIEW

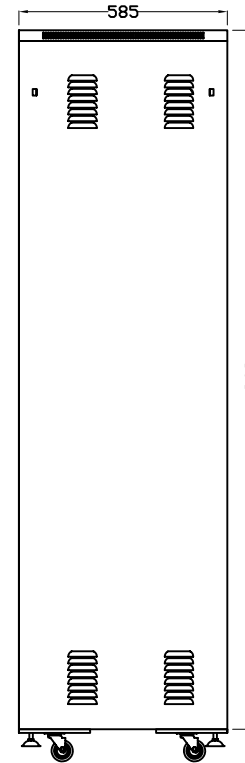

END VIEW

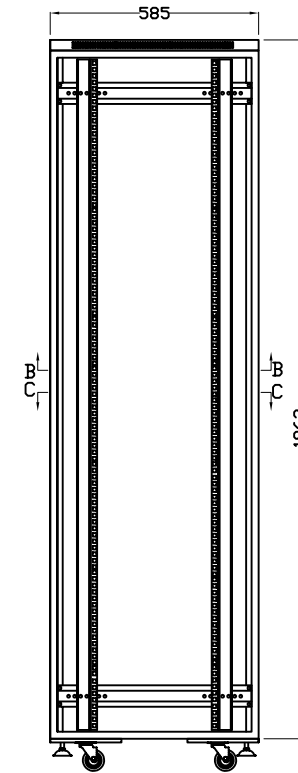

SECTION A-A